

# MODULARM® 75LCT TOUCH SCREEN MULTI-MONITOR AND 75LCT LEAD LAG (LL) INSTALLATION AND OPERATING MANUAL



**NOTICE**

Before installing, please thoroughly read these instructions so that you can fully benefit from all of the capabilities offered by the Modularm® 75LCT Multi-Monitor.

**C O N T E N T S**

<b>PRODUCT OVERVIEW</b>	<b>3</b>
75LCT	3
75LCT-LL LEAD LAG	4
<b>PRODUCT ACCESSORIES</b>	<b>5</b>
MC-1 MAGNETIC DOOR CONTACTS (INCLUDED)	5
IP-1 LIGHT CONTROL AND PANIC ALARM (OPTIONAL)	5
MD-1/MD1+2 MOTION DETECTOR (OPTIONAL)	5
<b>PRODUCT FEATURES</b>	<b>6</b>
AC POWER FAILURE ALARM	6
VISUAL ALARM ANNUNCIATION	6
<b>PRODUCT OPERATION</b>	<b>7</b>
LIGHTING CONTROL OPERATION WITHOUT ACCESSORIES	7
LIGHTING CONTROL OPERATION WITH MC-1 MAGNETIC DOOR CONTACTS	7
LIGHTING CONTROL AND PANIC OPERATION WITH IP-1 INSTALLED	8
LIGHTING CONTROL AND PANIC OPERATION WITH IP-1 AND MC-1 INSTALLED	9
LIGHTING CONTROL AND PANIC OPERATION WITH IP-1, MC-1 AND MD-1 OR MD-1+2 INSTALLED	10
<b>CONFIGURATION MODE</b>	<b>11</b>
VIEW SETTINGS	11
PROGRAM	11
SLEEP MODE	12
RUN MODE	12
PREVENTATIVE MAINTENANCE MODE	12
75LCT RETURNS TO RUN MODE AFTER 10 SECONDS OF INACTIVITY	13
PROBE CALIBRATION	13
RINGBACK DELAY	13
LIGHTS OFF DELAY	13
ALARM RELAY	13
THE TWO RELAY MODES ARE	14
<b>75LCT-LL LEAD LAG</b>	<b>14</b>
LEAD LAG (LL) OPERATION	14
IDLE MODE OPERATION	15
PROGRAMMING	16
INSTALLATION, GENERAL SAFETY MEASURES AND PRODUCT LIMITATIONS	17-19
<b>75LCT-LL LEAD LAG MODULE ONLY</b>	<b>19</b>
LEAD-LAG MODULE STANDARD ACCESSORIES AND BUILDING CONNECTION SCHEMATIC	19
<b>75LCT TOUCH SCREEN</b>	<b>20</b>
Modularm 75LCT Standard accessories and building connection Schematic	20
<b>75LCT APP</b>	<b>21-22</b>
<b>SPECIFICATIONS</b>	<b>23</b>

## PRODUCT OVERVIEW

### 75LCT



The 75LCT can provide temperature, door ajar, AC failure and panic alarms with touch screen convenience. The system saves energy, improves efficiency, reduces coil icing, lowers maintenance costs and helps to maintain product integrity.

**The 75LCT offers the following functions, including patented operation:**

- Autodetect accessories
- AC Failure Alarm with built-in rechargeable battery and built-in recharging circuitry
- Door Ajar Alarm (requires MC-1 Magnetic Contacts)
- Panic (Entrapment) Alarm (requires optional IP-1 Illuminated Button)
- Manual and patented timed light control
- HACCP monitoring (additional equipment required)
- Remote notification (additional equipment required)
- Built-in audible alarm
- RS232 & RS485 communication ports
- Preventive maintenance reminder
- Localized for German, Spanish, Portuguese and French markets

**Use the 75LCT to monitor:**

- Reach-In's
- Walk-In's
- Temperature
- Evap
- Door Openings
- Condenser

## PRODUCT OVERVIEW

### 75LCT-LL LEAD LAG



The 75LCT-LL Lead Lag unit is used when two refrigeration systems are installed in applications that require a backup refrigeration system in the event of a system failure. The 75LCT will alert the operator and switch to the fallback system to avoid spoilage or an elevated temperature condition.

**The 75LCT-LL Lead Lag offers:**

- Autodetect accessories
- AC Failure Alarm with built-in rechargeable battery and built-in recharging circuitry
- Door Ajar Alarm (requires MC-1 Magnetic Contacts)
- Panic (Entrapment) Alarm (requires optional IP-1 Illuminated Button)
- Manual and patented timed light control
- HACCP monitoring (additional equipment required)



## PRODUCT ACCESSORIES

The accessories listed below connect directly to, and are powered by, the 75LCT. These accessories may be used individually, or in combination, to meet the unique requirements of each installation.

**AUTODETECT TECHNOLOGY** is standard on the 75LCT and automatically senses and integrates connected Modularm accessories into device operation without requiring any programming.

### MC-1 MAGNETIC DOOR CONTACTS (INCLUDED)

- Senses door status
- Provides door ajar and lights on switches based on status
- Runs on low voltage
- One set included with each 75LCT purchase

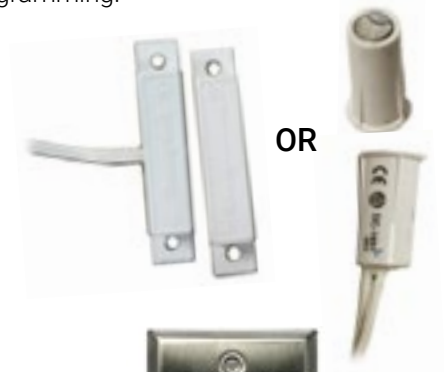

### IP-1 LIGHT CONTROL AND PANIC ALARM (OPTIONAL)

- Mounts inside the cooler/freezer
- Controls the cooler/freezer interior light
- Provides visual and audio panic alarms
- Runs on low voltage
- Optional purchase



### MD-1/MD1+2 MOTION DETECTOR (OPTIONAL)

- Mounts inside the cooler/freezer
- Detects motion to control the cooler/freezer interior light
- Runs on low voltage
- Optional purchase



## PRODUCT FEATURES









### AC POWER FAILURE ALARM



- 75LCT “chirps” every 30-seconds
- “Power Failure” displays on screen
- For power failures less than one-minute:
  - Normal operation restores automatically
  - Incident is ignored
- If power failure continues after one-minute:
  - Alarm relay activates for remote notification
  - The 75LCT will go dark to conserve battery life
  - Pressing the screen will wake the darkened unit
  - Status will again be displayed on screen

### VISUAL ALARM ANNUNCIATION

TABLE 1. STATUS OF THE 75LCT FOR ABNORMAL AND ALARM CONDITIONS TOUCH SCREENS

ALARM TYPE	ABNORMAL CONDITION	ALARM CONDITION	ALARM TYPE	ABNORMAL CONDITION	ALARM CONDITION
DOOR AJAR	Door Icon On Door Ajar Message Light Icon On No Audible Alarm		DOOR AJAR	Door Icon On Door Ajar Message Light Icon On Audible Alarm	
AC POWER FAILURE	Low Temp Alarm Out of Range Alarm Condition		PANIC ALARM	Display shows "HELP" Panic alarm initiated	
HI TEMP OUT OF RANGE	High Temp Alarm Out of Range No Alarm		TEMP OUT OF RANGE	High Temp Alarm Out of Range Alarm Condition	
LO TEMP OUT OF RANGE	Low Temp Alarm Out of Range No Alarm		LO TEMP OUT OF RANGE	Low Temp Alarm Out of Range Alarm Condition	

## PRODUCT OPERATION

Follow the Operating Instructions that relate to the Accessories included in your 75LCT System.

### LIGHTING CONTROL OPERATION WITHOUT ACCESSORIES



There are two options for controlling lights:

#### REGULAR TIMED LIGHTING (default)

- To turn lights on and activate the lights-off timer, press the “Light” button on the 75LCT
- The lights will turn off when the lights-off timer expires
- To manually turn lights off before the lights-off timer expires, press the “Light” button again when exiting

#### UNTIMED, MANUAL LIGHT CONTROL (replaces light switches)

- To turn lights on, press the “Light” button on the 75LCT
- To turn lights off, press the “Light” button again

### LIGHTING CONTROL OPERATION WITH MC-1 MAGNETIC DOOR CONTACTS



There are two options for controlling lights:

#### REGULAR TIMED LIGHTING (default)

- Open door to turn lights on
- The lights will turn off when the lights-off timer expires
- To manually turn lights off before the lights-off timer expires, press the “Light” button again when exiting

#### UNTIMED, MANUAL LIGHT CONTROL (replaces light switches)

- Open door to turn lights on
- Press the “Light” button again when exiting

## PRODUCT OPERATION

### LIGHTING CONTROL AND PANIC OPERATION WITH IP-1 INSTALLED



There are two options for controlling lights:

#### PATENTED TIMED LIGHTING (with AUTOPANIC enabled)

- To turn lights on and activate the lights-off timer and AutoPanic alarm, press the “Light” button on the 75LCT
  - IP-1 beeps and blinks for 40 seconds (when set to Timed Control)
  - Press the IP-1 within 40 seconds to:
    - “Check-in” and keep the lights on for as long as the door remains closed
    - Lock out the 75LCT “Light” button and prevent the light from being turned off from outside the walk-in
    - Activate the 20-minute AutoPanic timer (When enabled)
  - If the IP-1 is not pressed within 40 seconds, the lights will turn off
- After 20 minutes, the IP-1 beeps and blinks again for 40 seconds
  - Press the IP-1 to “check-in “ and restart the AutoPanic timer
  - The 20-minute alarm cycle will repeat for as long as a person remains in the walk-in without opening the door
  - If the IP-1 is not pressed within 40 seconds, the 75LCT will automatically sound a panic alarm (when enabled)

#### UNTIMED, MANUAL LIGHT CONTROL (replaces light switches)

- To turn lights on, press the “Light” button on the 75LCT
- To turn lights off, press the “Light” button again when exiting

## PRODUCT OPERATION

### LIGHTING CONTROL AND PANIC OPERATION WITH IP-1 AND MC-1 INSTALLED



There are two options for controlling lights:

#### PATENTED TIMED LIGHTING (with AUTOPANIC enabled)

- Open door to turn lights on
- When door is closed, the lights-off and AutoPanic timers activate
  - Press the IP-1 within 40 seconds to:
    - “Check-in” and keep the lights on for as long as the door remains closed
    - Lock out the 75LCT “Light” button and prevent the lights from being turned off from outside the walk-in
    - Activate the 20 minute AutoPanic timer
  - If the IP-1 is not pressed within 40 seconds, the lights will turn off
- After 20 minutes, the IP-1 beeps and blinks again for 40 seconds
  - Press the IP-1 to “check-in ” and restart the AutoPanic timer
  - The 20 minute alarm cycle will repeat for as long as a person remains in the walk-in without opening the door
  - If the IP-1 is not pressed within 40 seconds, the 75LCT will automatically sound a panic alarm

#### UNTIMED, MANUAL LIGHT CONTROL (replaces light switches)

- To turn lights on, press the “Light” button on the 75LCT
- To turn lights off, press the “Light” button again when exiting

## PRODUCT OPERATION

### LIGHTING CONTROL AND PANIC OPERATION WITH IP-1, MC-1 AND MD-1 OR MD-1+2 INSTALLED



There are two options for controlling lights:

#### PATENTED TIMED LIGHTING (with AUTOPANIC enabled)

- Open door to turn lights on
- When door is closed, the lights-off delay and AutoPanic timers activate
  - IP-1 beeps and blinks for 40 seconds
  - Press the IP-1 within 40 seconds to:
    - “Check-in” and keep the lights on for as long as the door remains closed
    - Lock out the 75LCT “Light” button and prevent the lights from being turned off from outside the walk-in
    - Activate the 20-minute AutoPanic timer
  - If the IP-1 is not pressed within 40 seconds, the lights will turn off
- After 20 minutes, the IP-1 beeps and blinks again for 40 seconds
  - Press the IP-1 to “check-in” and restart the AutoPanic timer
  - The 20-minute alarm cycle will repeat for as long as a person remains in the walk-in without opening the door
  - If the IP-1 is not pressed within 40 seconds, the 75LCT will automatically sound a panic alarm

#### UNTIMED, MANUAL LIGHT CONTROL (replaces light switches)

- To turn lights on, press the “Light” button on the 75LCT
- To turn lights off, press the “Light” button again when exiting



## CONFIGURATION MODE

### VIEW SETTINGS:

Displays the settings for the following parameters currently programmed in the 75LCT for a quick glance. Each parameter will have its own setup screen, as well as input limits (as defined in Table 2).

**Date** – Date in MM/DD/YYYY for US market; DD/MM/YYYY for non-US markets

**Scale** – F or C degrees

**Calibration Offset** – Offsets displayed temperature by preset amount

**High Limit** – High temperature threshold for sounding alarm

**Low Limit** - Low temperature threshold for sounding alarm

**Temp Delay** – Time delay in minutes, after which alarm condition is triggered for temperature exceeding the high or low limit thresholds

**Door Ajar Delay** – Time delay in minutes, after which alarm condition is triggered for door open/ajar

**Lights Off Delay** – Lights off timer, in minutes

**Lights Operation** – Lights operation mode (Timed and Manual)

**Ring Back Delay** – Delay for timed repeat audible alarms during an ongoing temperature alarm or power failure alarm condition

**Alarm Relay Mode** – Set mode of operation for relay (Latched and Unlatched)

**AutoPanic** – Set AutoPanic mode

### PROGRAM:

Allows user to configure/change default parameters. Table 2 lists the default settings, as well as the selection range for each of the parameters.

TABLE 2. PROGRAM MENU OPTIONS

MENU ITEM	SELECTION (RANGE)	DEFAULT
Date	Set Date and Local Time	Date and NYC Time
Scale	F or C	F
Calibration Offset <sup>2</sup>	-5 to +5 or -50F +50F	0
High Limit	-40F to 125F or -40C to 52C (1° interval)*	42F/6C cooler 10F/-12C Freezer*
Low Limit	-40F to 125F or -40C to 52C (1° interval)*	30F/1C cooler -20F/-29C Freezer*
Tem Delay	0 to 150 mins (1 m interval)*	60
Door Adjar Delay	0 to 60 mins (1 m interval)*	20 <sup>3</sup>
Lights Off Delay	0 to 150 mins (1 m interval)*	14 <sup>4</sup>
Lights Operation	Timed, Untimed	Timed
Ring Back Delay	0 to 150 mins (1 m interval)*	30
Alarm Relay Mode	Unlatched - Latched	Unlatched
AutoPanic	On <sup>6</sup> - Off	On - Off

**Sleep Mode:** The 75LCT ships from the factory in Sleep Mode.

The rechargeable battery is connected physically but is not connected electrically until AC power is applied.

<sup>2</sup> Calibration Offset shall not change Temperature Setpoints

<sup>3</sup> Value of 0 = feature deactivated/no delay

<sup>4</sup> Value of 0 = feature deactivated/no delay

<sup>5</sup> In Latched Mode, temp alarm condition, alternate display between "High/Low Temp" and Temp value in Red color

<sup>6</sup> AutoPanic = On & Lights Operation = Timed allowed only if MC-1 and either one or both IP-1 and MD-1/MD-2 installed

**Note:** The 75LCT-LL (Lead Lag) requires the battery to be connected on installation.

## CONFIGURATION MODE

### SLEEP MODE:

To restore Sleep Mode if the 75LCT has been powered up:



1. Connect to AC power. Press Gear Button. Scroll down to "SLEEP" and press and hold until the screen reads "Powering Off"
2. All functions are shut off
3. The battery automatically reconnects electrically the next time AC Power is applied

### RUN MODE:

All 75LCT monitoring functions take place in RUN Mode

#### NOTE THE FOLLOWING:

1. You must press Silence to clear a Temp Alarm or a Power Failure alarm even if the condition has corrected itself. This informs the operator if these alarm conditions happened, even if no one was present during the alarm
2. If door is being monitored, close the door to clear a Door Ajar Alarm
3. Open and close the door or press Silence to clear a Panic Alarm

### PREVENTATIVE MAINTENANCE MODE:

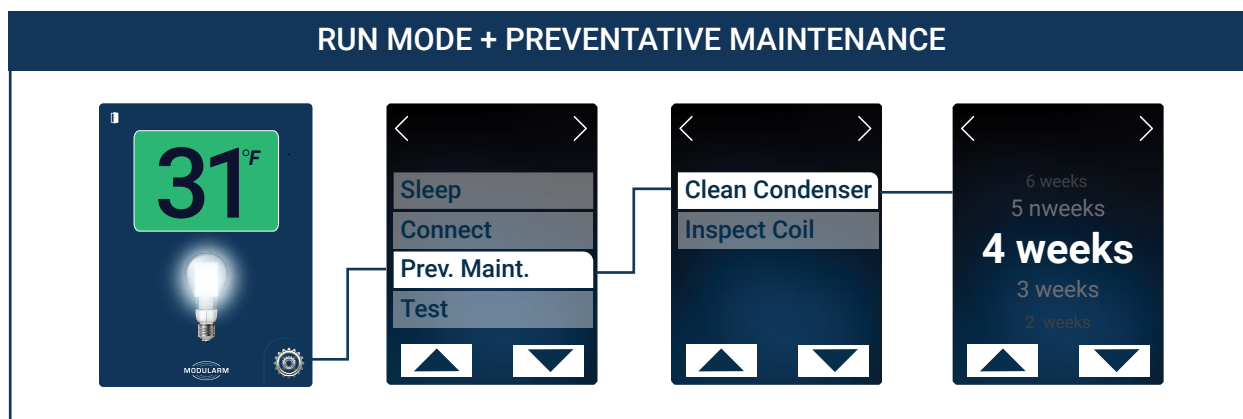

#### PREVENTIVE MAINTENANCE REMINDER

(75LCT) Programming Reminder to inspect coil and clean condenser:

1. Press Gear Button
2. Scroll down to "Prev. Maint."
3. Select Clean Condenser
4. Select time interval for reminder alert

#### TO ACTIVATE INSPECT COIL FEATURE

1. Press Gear Button
2. Scroll down to "Prev. Maint."
3. Select clean condenser
4. Select time interval for reminder alert

## CONFIGURATION MODE

75LCT RETURNS TO RUN MODE AFTER 10 SECONDS OF INACTIVITY

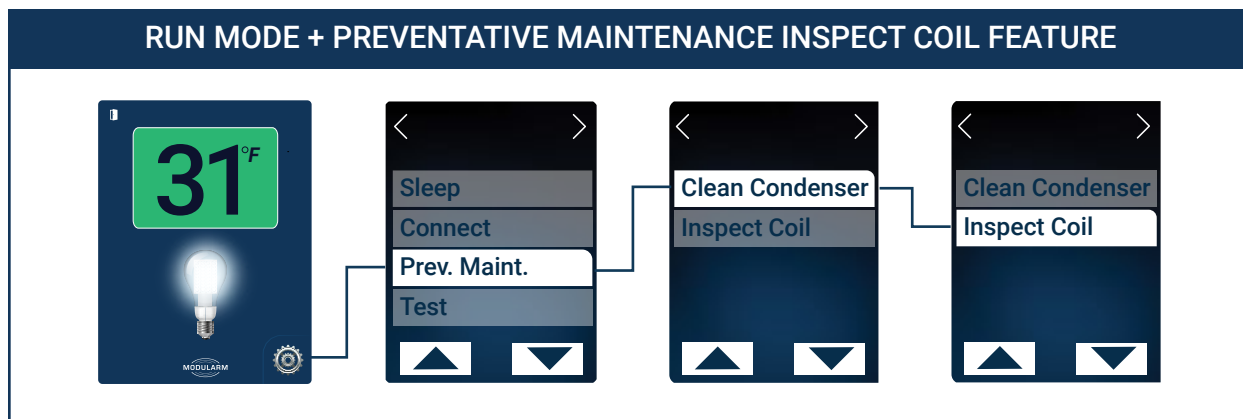

### TO ACTIVATE INSPECT COIL FEATURE

1. Press Gear Button
2. Scroll down to "Prev. Maint."
3. Select "Clean Condenser"
4. Select time interval for reminder alert

### PROBE CALIBRATION

The 75LCT comes pre-calibrated to read proper temperature with Automatic Scale Conversion from F to C. Calibration parameter provides a means for offsetting the displayed temperature by +/-5, if so desired.

1. Press Gear Button
2. Scroll down to "Probe Calibration"
3. Select value

**NOTE:** Calibrating offset doesn't change setpoints

### RINGBACK DELAY

Ringback provides a way to generate timed repeat audible alarms during an ongoing temperature alarm or power failure alarm condition.

Select the time interval you wish for this to occur.

1. Press Gear Button
2. Scroll down to "Ring Back Delay"
3. Select time

### LIGHTS OFF DELAY

The lights will turn off after the pre-programmed time (Factory default time is 14 minutes - field programmable).

1. Press Gear Button
2. Scroll down to "Light Off Delay"
3. Select time off delay

### ALARM RELAY

Normally Open (N/O) and Normally Closed (N/C) dry contacts are provided for low voltage of 28-30VDC at 1 amp. For main voltages, 120/240VAC, an external relay will be required.

## THE TWO RELAY MODES ARE:

**Unlatched** - Default Setting. Relay activates when alarm occurs and deactivates when Silence is pressed.

Typical Application: Controlling a remote buzzer or light

1. Press Gear Button to access menu
2. Scroll down to Unlatched Relay Mode
3. Select Unlatched

**Latched** – Relay activates when alarm occurs and deactivates when both the alarm condition has been cleared and Silence has been pressed. Typical Application: Connection to a building management system where relay remains activated until alarm condition clears and is acknowledged

1. Press Gear Button to access menu
2. Scroll down to Latched Relay Mode
3. Select latched

## 75LCT-LL LEAD LAG

### LEAD LAG (LL) OPERATION:

The 75LCT-LL unit is used when two refrigeration systems are installed in applications that require a backup refrigeration system in the event of a system failure. The 75LCT will alert the operator and switch to the fallback system to avoid spoilage or an elevated temperature condition.

The operation of the Lead Lag electronic toggle function works in conjunction with the normal temperature alarm logic in the standard 75LCT. In the event of a temperature alarm, the 75LCT will automatically switch to the other or alternate system, regardless of the system that was operating when the alarm occurred.

When an over temperature event occurs, the 75LCT will issue a command for the relay to latch to the alternate SYSTEM as a backup system and will switch to the working system (reactivated) until the temperature returns to normal and the alarm has been manually reset by the user. System A and System B time intervals can be selected from the programming menu screen. During an alarm condition, the toggle between systems is disabled until the temperature is once again within its normal limits.



## 75LCT-LL LEAD LAG

### IDLE MODE OPERATION:



- Ability to switch and latch on the alternate system in the event of a SYSTEM failure and the 75LCT operation sees an elevated temperature condition
- Once the alarm activates, the 75LCT-LL will alarm and the unit will switch to the alternate SYSTEM relay output after the programmed “Alarm Time Delay” is automatically met (e.g., 1 hour)
  - Solid color LED on Lead Lag Daughter Board = Good or active system currently in use
  - Flashing LED on Lead Lag Daughter Board = System with failure condition

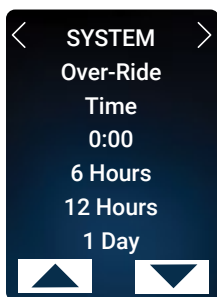

- User needs to acknowledge the SYSTEM Failure Alarm on the display to silence the alarm (One and done alarm unless ringback time is set to prompt the operator to manually override the system)
- Options for User Prompt for Manual Over-ride duration time can be scrolled, keeping the working SYSTEM latching during that time
  - 6 hours - 2 days
  - 12 hours - 3 days
  - 1 day



- User will need to repair, service or restore the failed system, and the temperature will need to be within temperature range within the standard delay time set in the 75LCT, to allow for appliance temperature to restore to normal conditions
- SYSTEM X (for clarity, SYSTEM X refers to SYSTEM A or SYSTEM B) will remain in operation automatically until the next timing interval for Lead Lag logic to switch
- There will be a manual selection by the user once the temperature is restored within proper range
  - Ability to manually select between system A or B in programming for technician testing
  - Ability to manually select between system A or B by user prompt for manual over-ride See ringback above in 3a
  - Upon entering and exiting programming mode, the display will ask the User to “Continue Manual Over-Ride? Y/N” for the remaining duration of the selected time interval

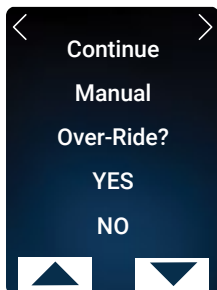

If set to Yes, the Manual Over-Ride is cleared and normal operation will resume. If set to NO, the Manual Over-Ride is not cleared and will remain in the SYSTEM Over-ride Condition until the override time interval has expired and the temperature of the walk-in is within the proper range, at which time the 75LCT-LL will attempt to resume its normal Lead Lag operation

- During all operations, standard 75LCT functions remain in their current state:
  - Light Control
  - Temp Delays
  - Temperature Alerting
  - Motion Sensing
  - Panic Button Operation
  - Ring Back Alarm
  - Dry Contacts Enabled during alarm conditions
  - Preventative Maintenance Alerts: Clean Condenser, Inspect Coils
  - Alarms (Temperature Hi, Temperature Lo, Panic, Temp Probe Failure, etc.)

### 75LCT-LL LEAD LAG

**PROGRAMMING:**

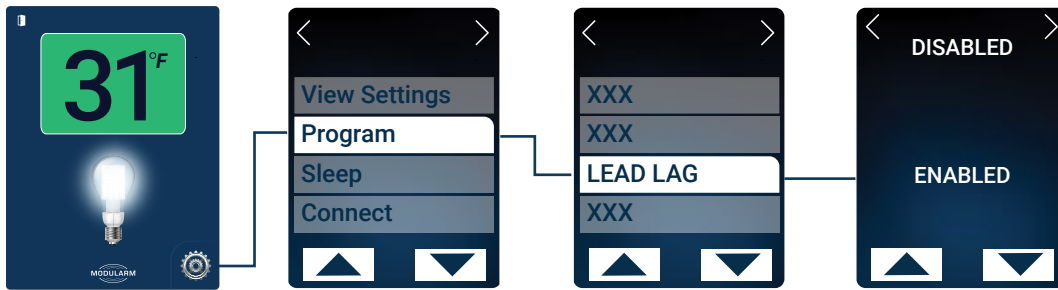

1. Press Gear Button on screen
2. Scroll down to Lead Lag option in menu programming
3. The "Lead Lag" parameter can be enabled/disabled here
  - If disabled, the logic will continually latch SYSTEM A output
  - If enabled, the time intervals shown below will be available to switch the relay operation
4. View and set parameters to select the interval timer between switching SYSTEM A and SYSTEM B cooling systems. The unit always begins with SYSTEM A as the primary system/output
5. A parameter that selects the interval timer SYSTEM A will be enabled prior to switching to SYSTEM B

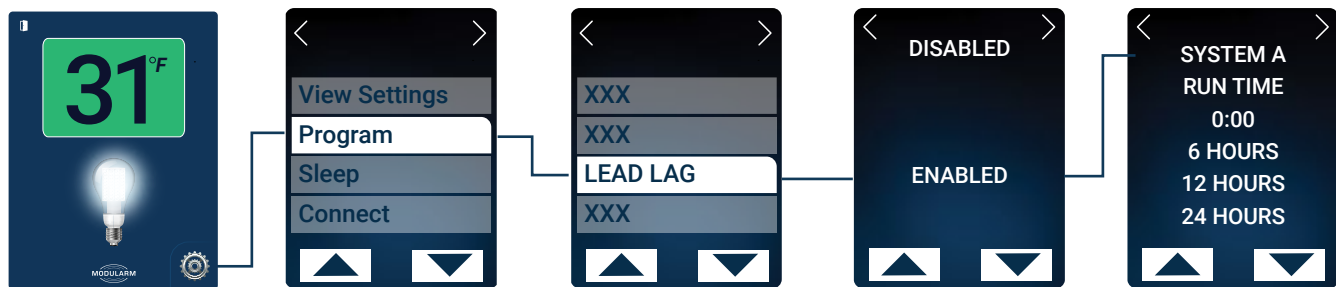

- SYSTEM A Run Time (Scrolling Choices)
  - 6 hours
  - 2 days
  - 5 days
  - 8 days
  - 11 days
  - 14 days
  - 12 hours
  - 3 days
  - 6 days
  - 9 days
  - 12 days
  - 15 days
  - 1 day
  - 4 days
  - 7 days
  - 10 days
  - 13 days
- A parameter to select the interval timer for SYSTEM B will be enabled prior to switching to SYSTEM A.

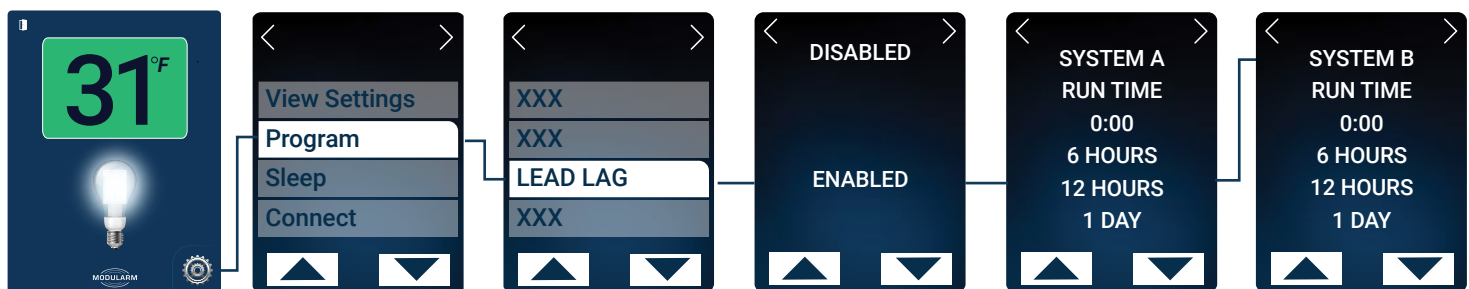

- SYSTEM B Run Time (Scrolling Choices)
  - 6 hours
  - 2 days
  - 5 days
  - 8 days
  - 11 days
  - 14 days
  - 12 hours
  - 3 days
  - 6 days
  - 9 days
  - 12 days
  - 15 days
  - 1 day
  - 4 days
  - 7 days
  - 10 days
  - 13 days



## 75LCT TOUCH SCREEN

### INSTALLATION, GENERAL SAFETY MEASURES AND PRODUCT LIMITATIONS

- This product ("Product") must be installed by a licensed electrician experienced in working in the types of environments for which this Product is intended to be utilized; specifically, commercial Cooler/Freezer coolers and freezers ("Equipment").
- Personnel installing the Product must carefully and completely read the Operating and Installation Instructions ("Instructions"), and instructions and specifications of the Equipment manufacturers, before attempting to operate and install the Product. Failure to comply with the Instructions, and the instructions and specifications of the Equipment manufacturers, may result in personal injury and/or property damage and may void the warranty of the Product. Retain the Instructions for future reference.
- The Product shall only be used for the purposes described in the Instructions.
- During installation of the Product, all applicable laws, regulations and industry rules, including local electrical and safety codes, the National Electric Code (NEC) and the Occupational Safety and Health Act (OSHA), must be strictly followed. Consistent therewith, follow applicable electrical codes regarding running of low voltage wiring and high voltage wiring in separate conduits and use appropriately rated wire (insulation type, voltage rating and wire gauge) for all connections. Supply connection wiring must be rated at least 90°C. Use copper conductors only.
- Confirm that the power source conforms to the requirements of the Product before connecting.
- Do not exceed the rated limits of the Product. Refer to the Product specifications for suitability of the Product to the application.
- The Product is not suitable for use in wet locations. Do not expose the Product to water, moisture or condensation. In no event should the Product be exposed to environments where sudden temperature changes with high humidity may result in the formation of condensation.
- Any openings in the walls, ceiling or floor of the Equipment for wiring or other reason must be sealed (made airtight and watertight) with appropriate materials (e.g., silicone, caulk or foam), both on the outside and inside of the Equipment, to prevent moisture or condensation from entering the compartment of the Equipment and forming and accumulating on the interior walls of the compartment and the contents of the compartment, including the Product. Failure to properly seal such openings may (i) result in damage to the Equipment and contents of the compartment (ii) pose a safety hazard and (iii) void the warranty of the Product.
- To prevent moisture or condensation from entering or forming in the enclosure used for the Product, any openings in this enclosure (for wiring access or other purpose) must be appropriately sealed with materials such as silicone, caulk or foam.
- Installation of the Product should be inspected and the Product tested by qualified personnel to ensure the Product performs safely and in accordance with the Product specifications. Periodic testing of the Product should be performed on an ongoing basis (at least quarterly) to ensure the Product continues to perform properly.
- All personnel operating, maintaining, repairing or interfacing with the Product must be instructed in the use of the Product and provided with the Instructions, which are accessible on the Kitchen Brains website at [www.kitchenbrains.com](http://www.kitchenbrains.com).
- **WARNING:** Hazard of electric shock! Power sources must be turned off or otherwise disconnected prior to installation or servicing of the Product. Lock and tag power disconnects to prevent an unexpected application of power.

INSTALLATION, GENERAL SAFETY MEASURES AND PRODUCT LIMITATIONS

<p><b>Mounting the Enclosure For the 75LCT</b></p>	<p>Any enclosure used for 75LCT mounting must provide multiple wire access hubs for running line voltage wiring and low voltage wiring in separate conduits. Determine the wire access hubs to be utilized for the installation and plug and seal any remaining unused openings with hardware and/or sealant. The 75LCT will fit into a typical outdoor, single gang outlet box. Surface Mount – A typical outdoor, single gang outlet box may be used for surface mounting. Mount the enclosure vertically onto the desired surface. If fastening the enclosure with screws directly through the back wall of the enclosure, use two screws, centered vertically above and below the opening in the rear of the enclosure. Once the cutout and mounting holes have been made, screws in the mounting holes may be used to hold the selected enclosure in place during the foaming process.</p>
<p><b>Mounting the IP-1</b></p>	<p>The IP-1 may be flush mounted into a standard J-Box. A typical outdoor type single gang outlet box may be used for surface mounting. <b>(NOTE:</b> The IP-1 is a low voltage device. Wiring to the IP-1 must not be installed in the same conduit as line voltage wiring. An 8' length of color-coded wiring for connecting the IP-1 is provided.) Typical mounting location for the IP-1 is inside of the Cooler/Freezer adjacent to the door. Any wire pathways or other openings leading into the enclosure for the IP-1 from outside of the Cooler/Freezer must be sealed both on the outside and on the inside of the walk in to prevent a pathway for condensation.</p>
<p><b>Mounting the MD-1/MD-1+2</b></p>	<p>The MD-1/MD-1+2 may be flush mounted into a standard J-Box. A typical outdoor type single gang outlet box may be used for surface mounting.</p> <p><b>(NOTE:</b> The MD-1/MD-1+2 is a low voltage device. Wiring to the MD-1/MD-1+2 must not be installed in the same conduit as line voltage wiring. A 6' length of color coded installation wiring is pre-connected to the MD-1/MD-1+2). Typical mounting location for the MD-1/MD-1+2 is inside of the Cooler/Freezer above the door. There is no need to open or access the motion detector itself.</p> <p>Mount the MD-1/MD-1+2 horizontally with the white oval lens facing down. The red light inside of the MD-1/MD-1+2 will illuminate whenever the MD-1/MD-1+2 is activated.</p> <p><b>WIRING:</b> See <b>Wiring Diagrams</b>. Keep wiring relatively short inside of the enclosure for the 75LCT. <b>Make sure that wiring openings into all enclosures are sealed properly to prevent a pathway for condensation.</b></p>
<p><b>Line Voltage Wiring</b></p>	<p>The low voltage terminal blocks will accept wire from 24-16AWG. Accessories and sensors are typically provided with 24-22AWG wire. General Accessories and sensor connections are shown on the accompanying <b>75LCT Connections</b> diagram. See page 19 Connections are also marked on the 75LC. See the diagrams labeled <b>"IP-1 Connections"</b>, <b>"MD-1/MD-1+2 Connections"</b>, and <b>"IP-1 &amp; MD-1/MD-1+2 Connections"</b> for wiring specific to your application.</p>
<p><b>Low Voltage Wiring</b></p>	<p>The stripped end of the low voltage wire connections should be kept short, approximately ¼" long. To connect wires, press down on the respective plunger on the top of the terminal block, insert the wire into the respective hole and release the plunger. Tug on wires to make sure connections are secure and that they are grabbing bare wire and not insulation.</p> <p><b>(NOTE:</b> If the IP-1 and the MD-1/MD-1+2 are both being used, use the enclosure for the IP-1 as a junction box for connecting the MD-1 in accordance with the <b>"IP-1 &amp; MD-1/MD-1+2 Connections"</b> diagram. Connect the green wires together in the IP-1 enclosure with a wire nut or other connector. Strip the 2 black wires approximately 3/8", twist together and insert both into the IP-1 block in accordance with the diagram. Do the same with the two red wires. Again, tug gently on all wires to make sure connections are secure.)</p>
<p><b>Temperature Probe Mounting</b></p>	<p>Run the probe into the monitored compartment and locate the sensor in a spot which will typify the average ambient temperature. <b>Recommended location is in the center of the ceiling.</b> Fasten the sensor with the provided clamp. Make sure sensor and sensor wire are positioned and/or protected so as not to be damaged by products or items in the monitored area. Seal any openings made for passage of the probe wire into the Cooler/Freezer on the inside and the outside of the Cooler/Freezer to prevent a pathway for condensation.</p>

INSTALLATION GENERAL SAFETY MEASURES AND PRODUCT LIMITATIONS

<p><b>Magnetic Contacts Mounting</b></p>	<p>Mounting method will vary depending on the type of contacts utilized. Make sure that the operating gap between the magnet part and the switch part of the contacts accurately detects a door open or a door closed condition. (The DOOR light is on constantly when the door is open. This light may be utilized to assist in proper switch and magnet placement.) NOTE: For compartments with more than one door, multiple sets of contacts, wired in series, may be utilized to monitor multiple door's status.</p>
<p><b>Mounting the 75LCT onto the enclosure</b></p>	<p>Mount the 75LCT onto the enclosure with the provided mounting screws. If the 75LCT is mounted onto an outdoor type single gang outlet box, route all wiring away from the battery when the 75LCT is inserted. Inspect the installation for compliance with electrical code, safety, sealing against moisture and condensation, and test to confirm that the Product and installation are operating properly in accordance with these instructions. Periodic testing is recommended to ensure continued proper operation.</p>

**75LCT-LL LEAD LAG MODULE ONLY**

LEAD-LAG MODULE STANDARD ACCESSORIES AND BUILDING CONNECTION SCHEMATIC

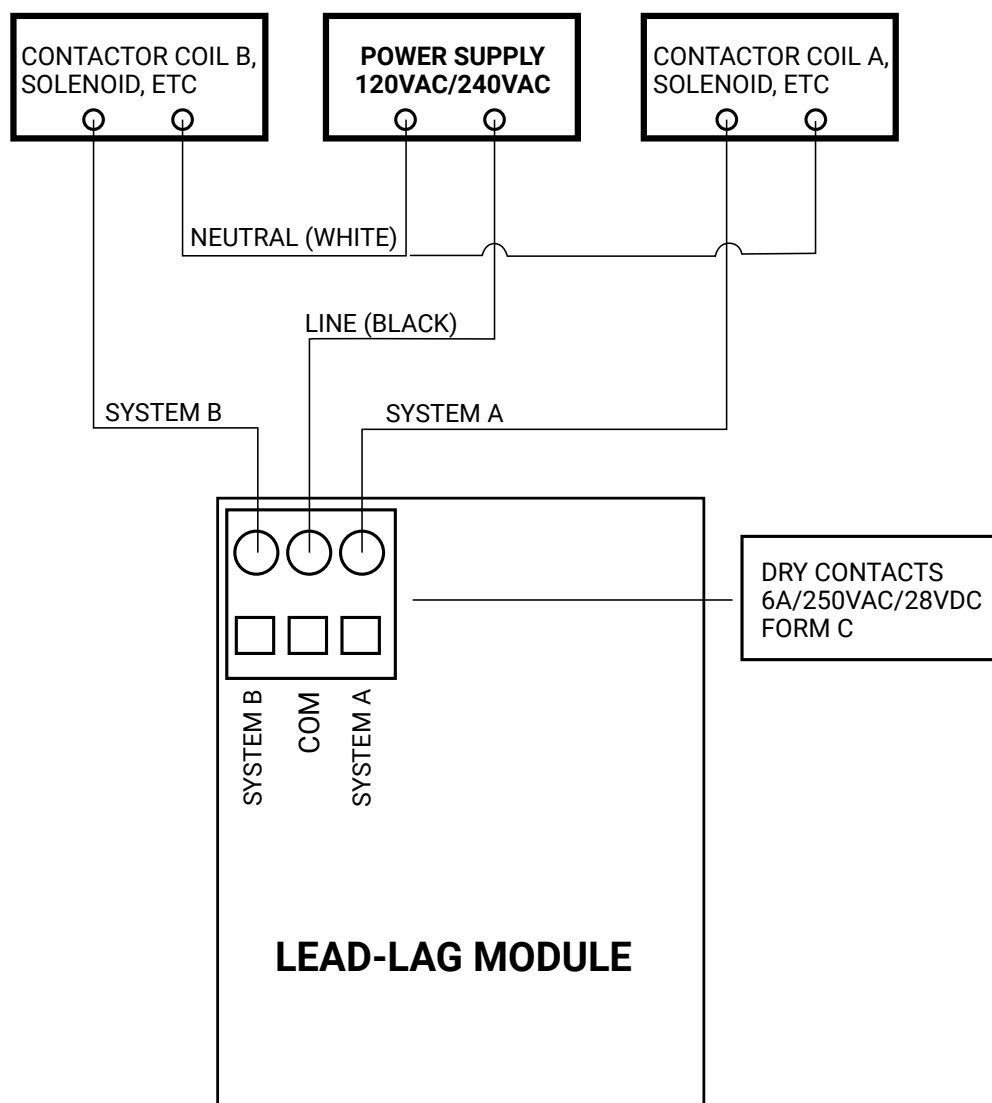

### 75LCT TOUCH SCREEN

#### MODULARM 75LCT STANDARD ACCESSORIES AND BUILDING CONNECTION SCHEMATIC

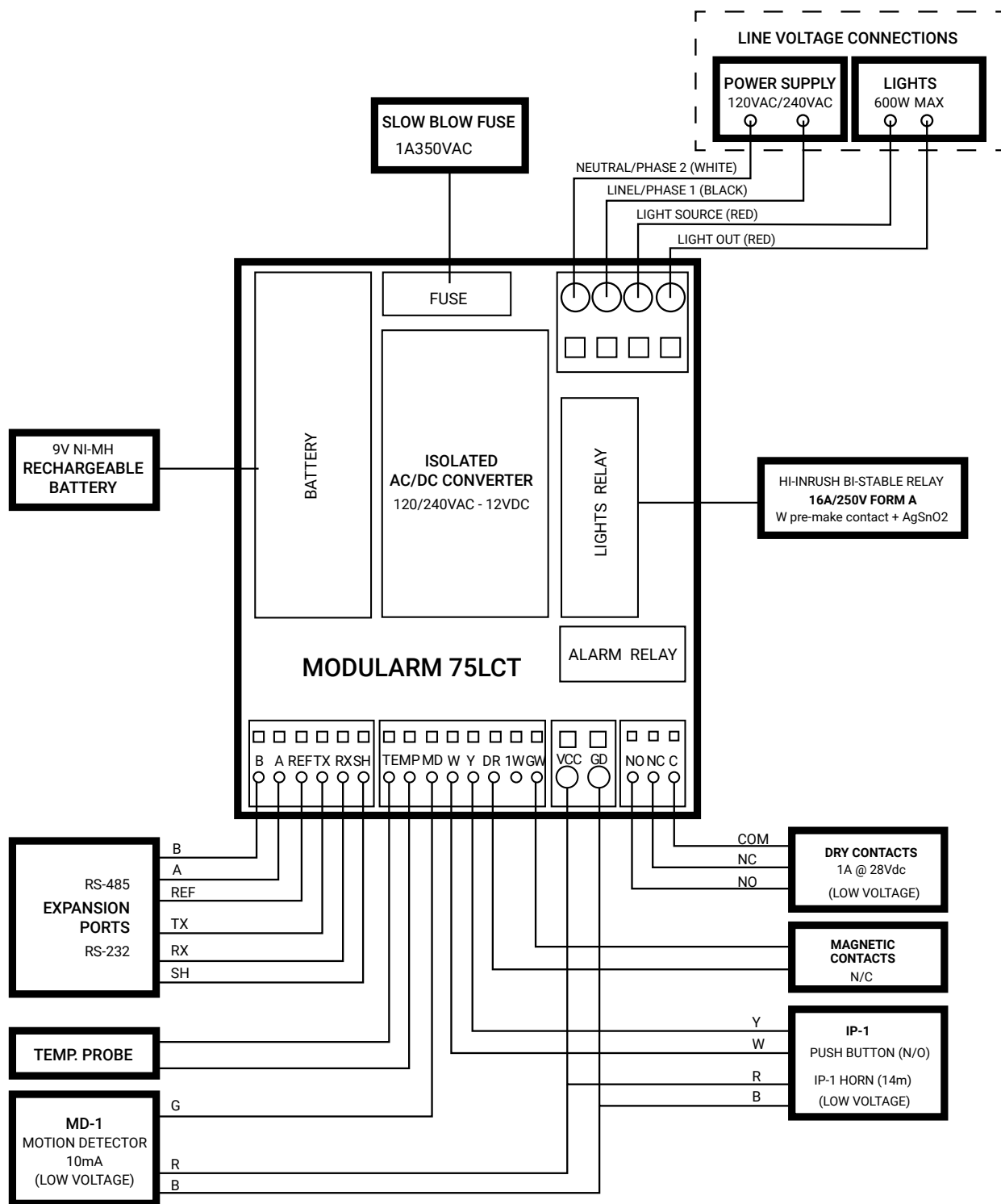

## 75LCT TOUCH SCREEN MULTI-MONITOR APP

Use this app to update the Kitchen Brains® Modularm 75LCT Multi-Monitor to the latest firmware version via Bluetooth connection.



### 1. LOCATE THE APP

- In the Apple App Store or Google Play on your mobile device, insert **“Modularm”** in the search field
- Download the 75LCT App to your mobile device

### 2. DOWNLOAD AND LAUNCH

- Locate the App on your device and click to launch
- The App will request the Administrator Password
- Enter password: 0000, then press submit
- The App will display all 75LCT units within range

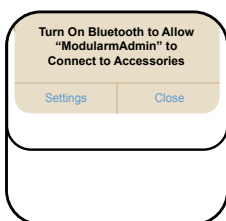
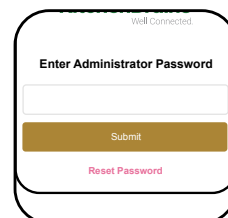

### 3. YOUR SETTINGS

- In Settings, turn on Bluetooth for the Modularm® 75LCT Multi-Monitor to allow the **“ModularmAdmin”** to connect

### 4. UPDATE FIRMWARE

- While connected to a WiFi or cellular network, you can download to your Mobil device the latest 75LCT Firmware from the Kitchen Brains Server

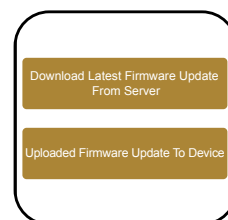

### 5. UPDATE FIRMWARE

- The App will confirm that you have the latest 75LCT Firmware version available for download. (Compare this to Software ID in the 75LCT Menu)

### 6. DOWNLOAD FIRMWARE

- The 75LCT Firmware download will begin

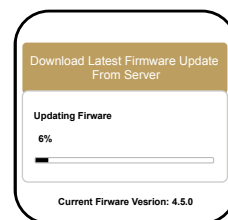

### 7. DOWNLOAD COMPLETE

- You will receive notification when the 75LCT Firmware download is complete



## 75LCT TOUCH SCREEN MULTI-MONITOR APP

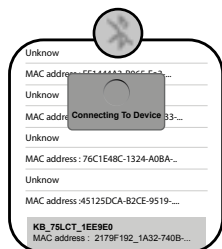

### 8. ENABLE BLUETOOTH AND PAIR DEVICE

- You will need to verify that your Bluetooth is enabled on the 75LCT, then press the Bluetooth icon (Step 7: View the icon in the top right corner). The app will then require you to locate and pair your device to the 75LCT

### 9. CONNECT YOUR DEVICE

- App will show that your device is connected to the 75LCT, then press "OK"



### 10. UPLOAD FIRMWARE

- Select "Upload the 75LCT Firmware Update To Device"

### 11. DOWNLOAD FIRMWARE

- App will download 75LCT Firmware to the 75LCT

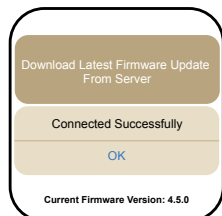
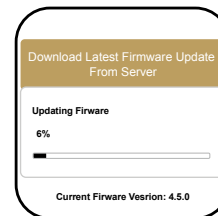

### 12. DOWNLOAD COMPLETE

- App will alert you when the 75LCT Firmware Update is complete

### 13. UPDATE COMPLETE

- When firmware updates are complete, press the icon in the top right corner and disconnect your Bluetooth device from the 75LCT
- Repeat steps 8 - 13 for each additional 75LCT that requires a firmware update

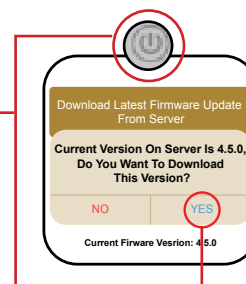



## SPECIFICATIONS



### 75LCT-LL Lead Lag

#### DIMENSIONS

10.72" L x 4.77" W x 2.05" D

#### POWER SUPPLY

90-240VAC @ 100mA max

#### AMBIENT TEMPERATURE

-10°C to 52°C°

#### CABLE LENGTH

30 meters max

#### LIGHTS RELAY

600W, 120/240VAC

#### ALARM RELAY

1A, 28VDC (RESISTIVE) CLASS 2

### LEAD LAG RELAY (LL Installs Only)

120/240VAC @ 6 AMP; 28VDC @ 6 AMP

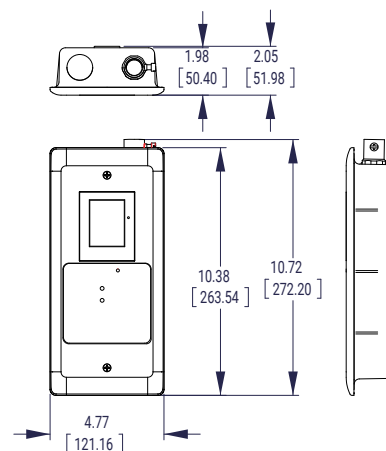

### IP-1 Illuminated Panic Button

#### DIMENSIONS

4.5" L x 2.75" W x 2.0" D

#### POWER SUPPLY

5VDC to 16VDC @ 20mA max from 75LCT

#### AMBIENT TEMPERATURE

-40°C to 40°C (-40°F to 104°F)

#### CABLE LENGTH

30 meters max

#### HUMIDITY

90% Noncondensing

#### MOUNTING

Outdoor, single gang outlet box  
Alternate enclosure for mounting must be UL listed enclosure, providing multiple wire access hubs for running low voltage.



### MC-1 S Door Contacts

SURF: 2-3.3 VDC @ 100mA max

Metal: 3.3 VDC@0.5A max from 75LCT

#### AMBIENT TEMPERATURE

-10°C to 52°C (-14°F to 126°F)

#### CABLE LENGTH

30 meters max

### MC-1 F Door Contacts



### MD-1 Motion Detector

9VDC to 15VDC @ 10mA max from 75LCT

#### AMBIENT TEMPERATURE

-10°C to 50°C (-14°F to 122°F)

#### CABLE LENGTH

30 meters max





Save these instructions for future reference.

**24/7 Toll-Free Technical Support**

In the U.S., Canada and the Caribbean

**1-800-FASTRON (1-800-327-8766)**

Elsewhere

**1-203-377-4414**

or

**[saashelpdesk@kitchenbrains.com](mailto:saashelpdesk@kitchenbrains.com)**

**KitchenBrains™**

Well Connected.

905 Honeyspot Road, Stratford, CT 06615 | [kitchenbrains.com](http://kitchenbrains.com) | 203-377-4414 | 800-327-8766

**CONNECTICUT | FLORIDA | LONDON | SHANGHAI | SINGAPORE**

© 2021 Kitchen Brains | Confidential Proprietary Information | Duplication Prohibited 229-40031B

