

Tracker Timer Model 26

12-DISPLAY TIMER

Specifications

Mechanical

- 20 ga. (.036") stainless steel enclosure
- Polyester face with back-printed text
- Faceplate: polyester with back-printed text and removable menu strip
- Maximum ambient temperature: 158°F / 70°C, 90% max. RH non-condensing

Electrical

- Power Input: 90-240VAC, 50/60 Hz
- Current less than 0.5 amp
- 12 Four-Digit Displays: .625"H, 14-segment green LED
- Action Alarms: 1 per stage
- Indicators: green LED
- Power Cord: Removable 90-degree angle, 6-ft. oil-resistant neoprene, grounded
- Audio Output: 78 db @ 6 feet
- Solid-state integrated circuit design
- Switch life rating: 10 million cycles
- Status indicators rated life: 50,000 hours
- Noise spike protection: 4000 Volt Minimum (on timers and all properly installed controls)

Shipping Weight

- Approx. 10 lbs. (4.53 Kg)

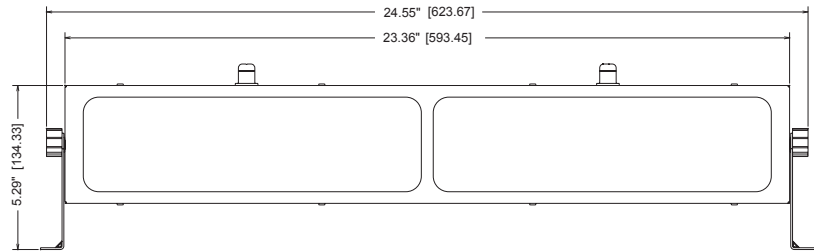

Bottom Mount

Wall Mount

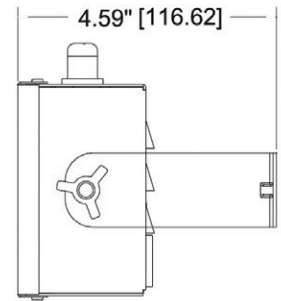
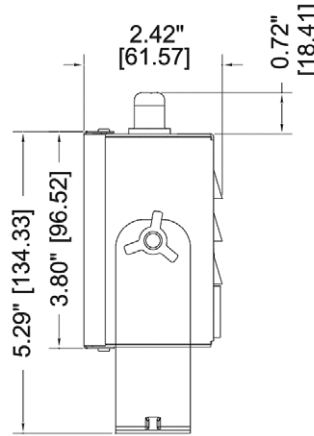

Order Info

Part Number	Description
TRACK2X6	Tracker Model 26 standard
TRACK2X6CP	Tracker Model 26 with communication port
TRACK2X6CPM	'Master' Tracker Model 26 with comm. port for peer-to-peer function
TRACK2X6CPS	'Satellite' Tracker Model 26 with comm. port for peer-to-peer function

NOTE: When ordering, indicate voltage and type of line cord required.

